

CATALOG

CENTRAL GARASI

PINTU GARASI BESI

SERVICE & QUALITY

SINCE 2005



Alamat :
Jalan Taman Makam Pahlawan
RT.02 RW.01, Kebon Duren
Kalimulya, Cilodong, Kota Depok
Pos: 16413

ABOUT CENTRAL GARASI

CENTRAL GARASI adalah perusahaan manufaktur yang telah berkecimpung didunia pintu garasi besi sejak tahun 2005 dan mampu bertahan juga berkembang hingga saat ini.

Inovasi kami selalu mampu menembus pasar dan diminati para kontraktor - kontraktor besar maupun kecil. Memiliki rekanan diberbagai wilayah indonesia menjadikan kami mudah dijangkau oleh siapa saja.

Produk Central Garasi terdiri dari pengadaan pintu garasi besi, pintu ruko, Pintu Darurat, Partisi, Pintu Gerbang, Pintu Utama, Pintu Kamar, Jendela dan Cutting Laser.

Visi :
Menjadikan perusahaan yang unggul dan profesional

Misi :
Mengembangkan produk - produk berkualitas berbahan dasar plat besi

BRAND HI-SEN



HI-SEN sendiri merupakan merk dari Central Garasi yang sudah tidak asing lagi.

Logo HI-SEN mungkin sering anda jumpai pada pintu - pintu modern yang terbuat dari bahan plat besi.

Keunggulan pada produk HI-SEN adalah pemilihan bahan material yang berkualitas. Dibentuk dan didesain menggunakan alat - alat berteknologi modern juga tenaga kerja profesional.

PINTU GARASI BESI



Pintu garasi merupakan salah satu bagian rumah yang pada intinya adalah pintu biasa yang dipasang pada ruang garasi yang bertujuan agar sesuatu atau apapun yang ada didalam garasi tidak terlihat langsung dari luar dan juga sebagai pengaman, selain itu pintu garasi pada masa sekarang memiliki banyak manfaatnya antara lain menjadikan eksterior rumah agar terlihat lebih mewah dan elegan, dan juga bisa membuat nilai sebuah rumah meningkat.

Untuk bahan pintu garasi sendiri ada beberapa jenis yang sering digunakan diantaranya kayu dan besi.

Pintu garasi besi sekarang menjadi salah satu pilihan selain dari bahan kayu dikarenakan pintu garasi dari bahan besi ini lebih awet dan tahan lama,

perawatannya juga mudah banyak pilihan motif dan model yang bisa dipadupadankan dengan desain rumah yang akan dibuat, pintu garasi besi biasanya dipilih untuk rumah berkonsep minimalis modern tapi tidak lupa akan kebutuhan aslinya yaitu melindungi semua yang ada dalam ruang garasi.



Garasi Dorong Tikung

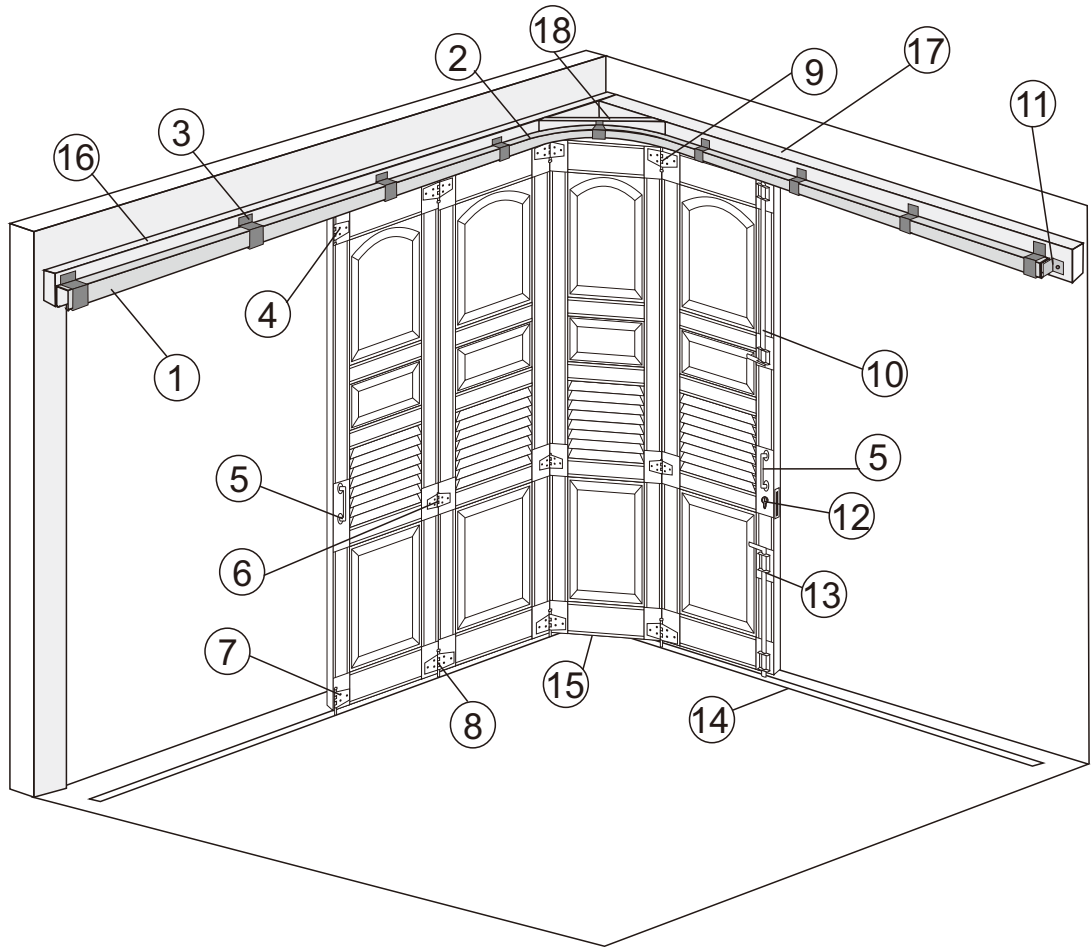

- | | | |
|---------------------|----------------------|--------------------|
| ① Rel Atas | ⑦ Roda Bawah Pinggir | ⑬ Grendel Roda |
| ② Rel Tikung Atas | ⑧ Roda Bawah Tengah | ⑭ Rel Bawah |
| ③ Brecket Samping | ⑨ Roda Atas Tengah | ⑮ Rel Tikung Bawah |
| ④ Roda Atas Pinggir | ⑩ Grendel Atas | ⑯ Papan Penunjang |
| ⑤ Handle PC | ⑪ Stopper Roda | ⑰ Balok Penunjang |
| ⑥ Engsel Tengah | ⑫ Kunci | ⑱ Siku Penunjang |

Note:
Banyaknya jumlah pintu ditentukan dari lebar opening
untuk ukuran standar pintu besi Lebar : 70cm, Tinggi : 240cm

Garasi Dorong Lipat

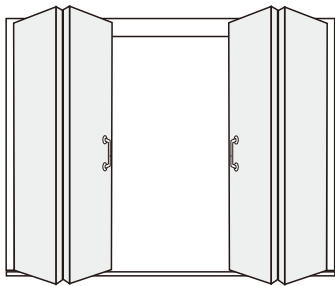
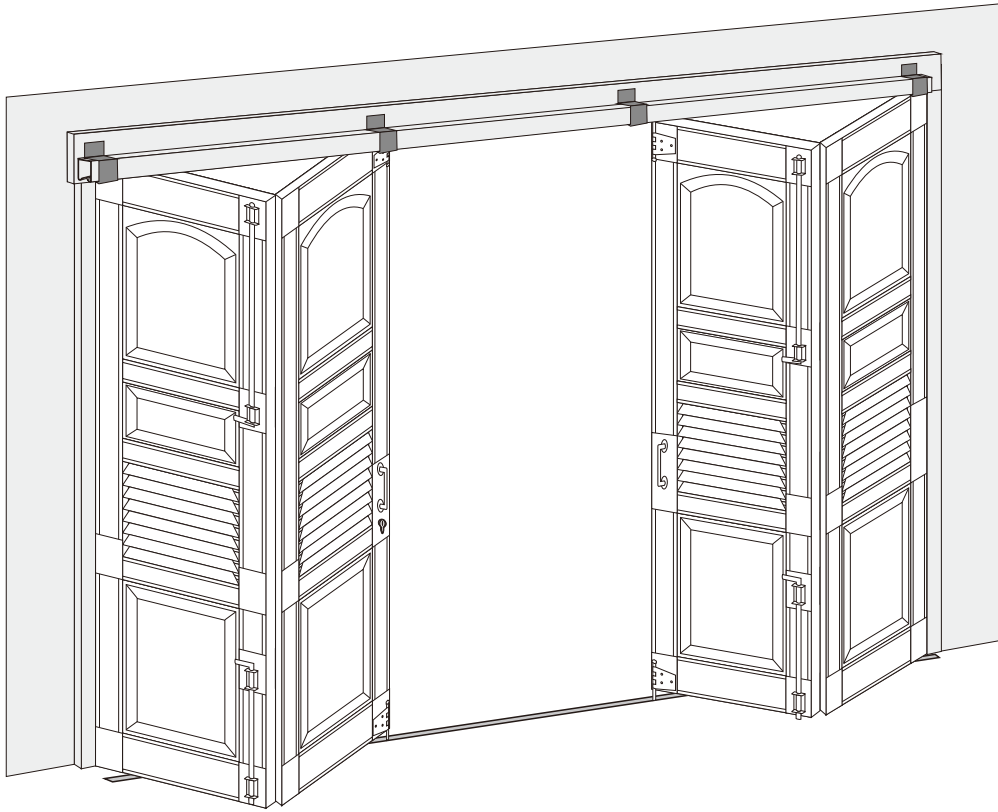

2 : 2

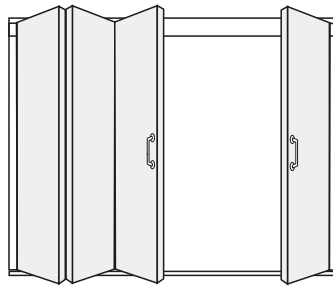

3 : 1

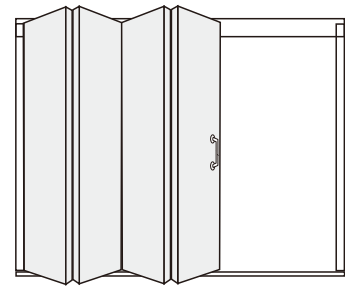

4 : 0

Note:

Banyaknya jumlah pintu ditentukan dari lebar opening
untuk ukuran standar pintu besi Lebar : 70cm, Tinggi : 240cm

***Ukuran Dalam Katalog Ini Harus Dikonfirmasi Kembali*

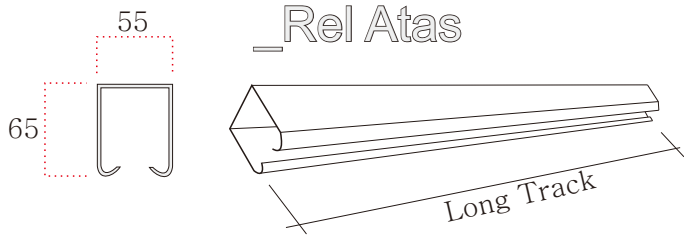

plate thickness : 1,8mm

Material	Long Track	Capacity
GALVANIS	2900 mm	250 Kg
	2400 mm	250 Kg
	1500 mm	250 Kg

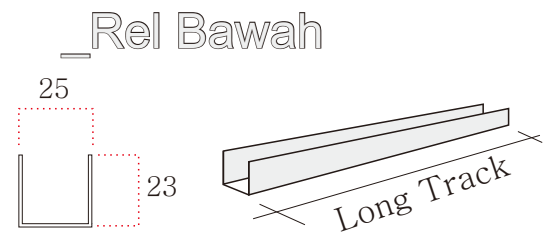
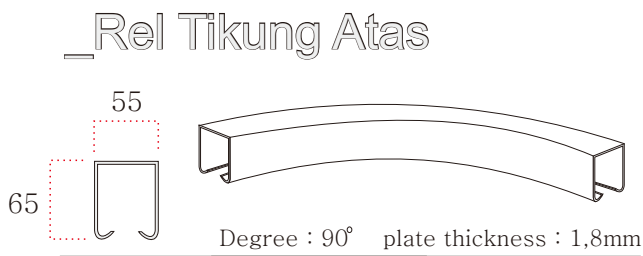
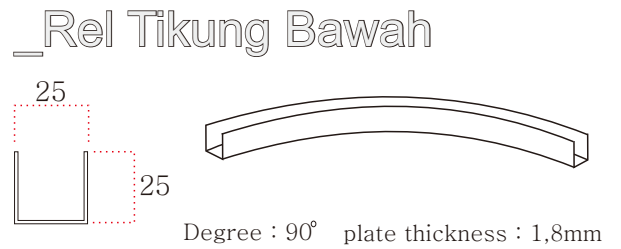

plate thickness : 1,8mm

Material	Long Track	Capacity
GALVANIS	2900 mm	-
	2400 mm	-
	1500 mm	-



Material	Long Track	Capacity
GALVANIS		250 Kg



Material	Long Track	Capacity
GALVANIS		-

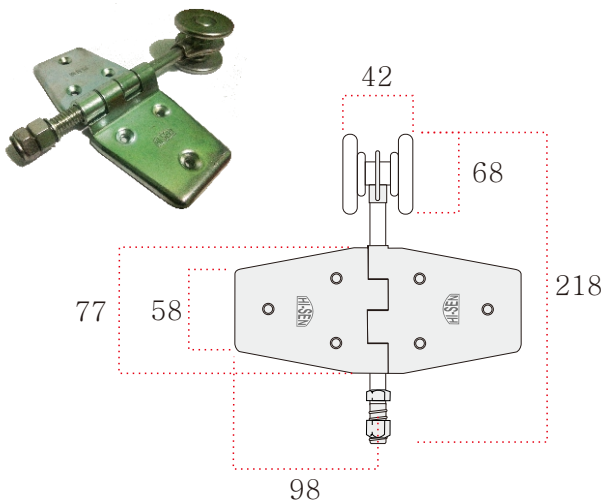

plate thickness : 3mm

_Roda Atas Tengah RD2

Type : **RD2**
 Material : Iron/besi
 Capacity : 90 Kg/Door Leaf

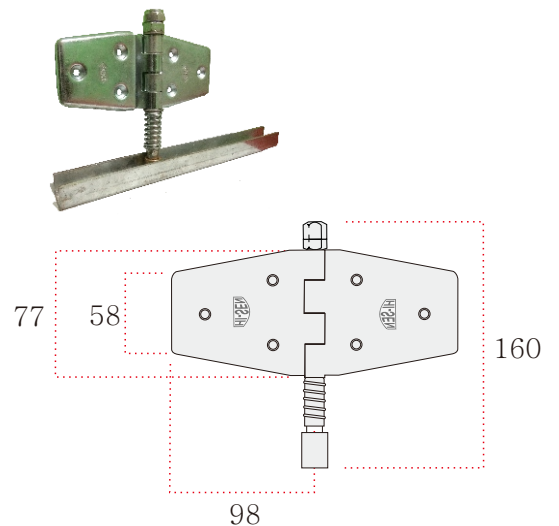

plate thickness : 3mm

_Roda Bawah Tengah

Type : **RBT**
 Material : Iron/besi
 Capacity : -

****Ukuran Dalam Katalog Ini Harus Dikonfirmasi Kembali**

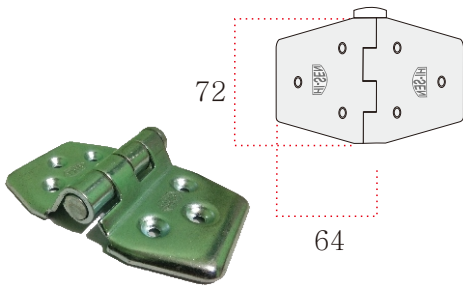

plate thickness : 3mm

_Engsel Tengah

Type : **ET**
 Material : Iron/besi
 Capacity : -

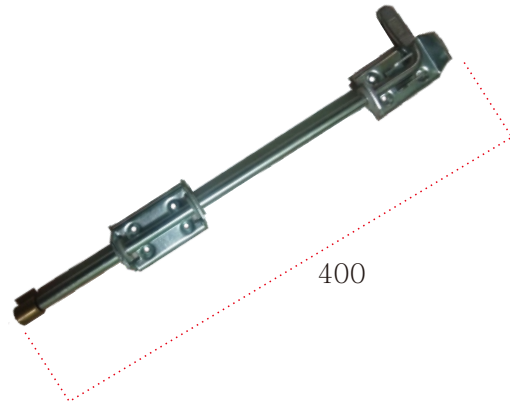
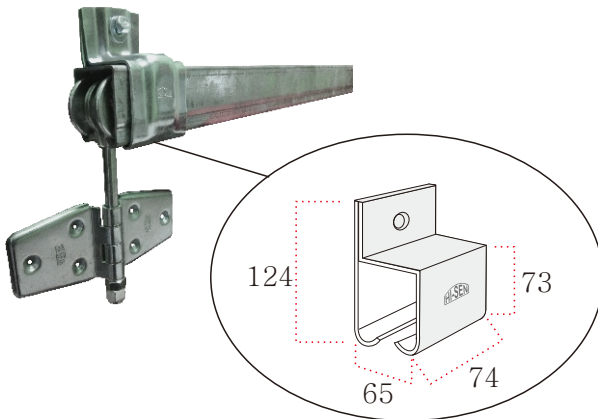

plate thickness : 3mm

_Grendel Roda

Type : **GR**
 Material : Iron/besi
 Capacity : -



_Brecket Samping

Type : **RD2**
 Material : Iron/besi

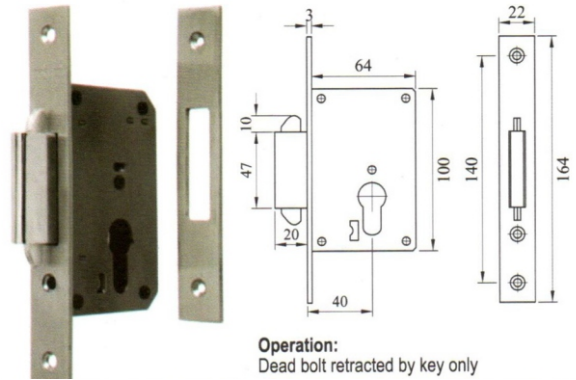

_Kunci Pintu Sliding

Type : **RD2**
 Material : Steel
 Capacity : -

****Ukuran Dalam Katalog Ini Harus Dikonfirmasi Kembali**

MOTIF - MOTIF PINTU

HI-SEN HS-01

Tebal Plat : 1,2mm / 1,5mm / 2mm
Finishing Cat Powder Coating

Bahan Plat Besi

**note : dapat dirubah sesuai permintaan*

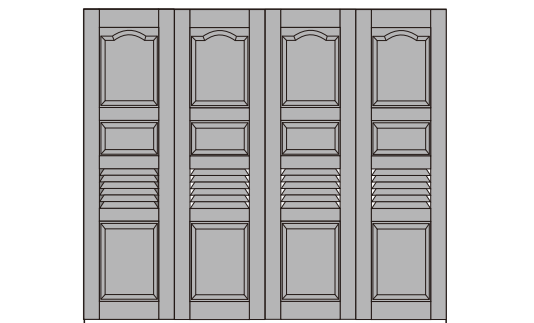

Ilustrasi 4 pintu tampak depan

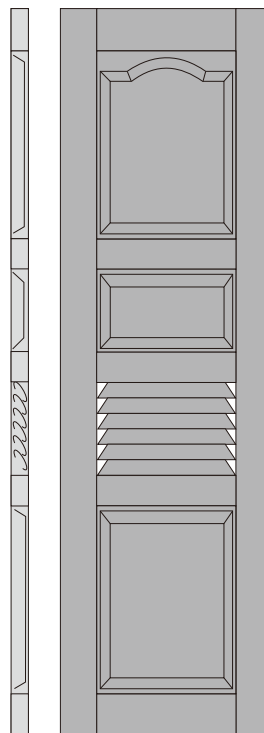

CODE : HS-01

HI-SEN HS-02

Tebal Plat : 1,2mm / 1,5mm / 2mm
Finishing Cat Powder Coating

Bahan Plat Besi

**note : dapat dirubah sesuai permintaan*

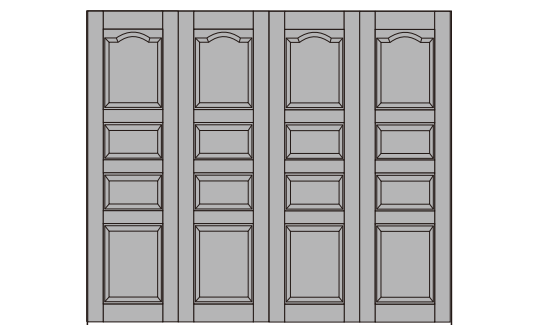

Ilustrasi 4 pintu tampak depan

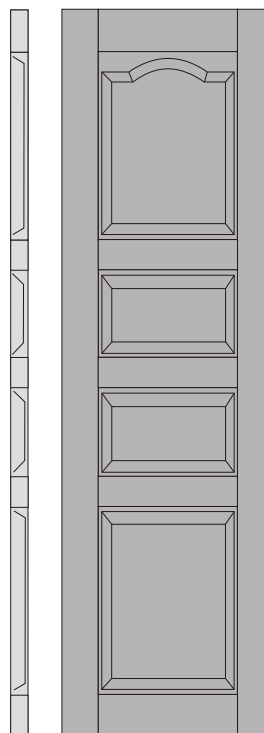

CODE : HS-02

HI-SEN HS-03

Tebal Plat : 1,2mm / 1,5mm / 2mm
 Finishing Cat Powder Coating

Bahan Plat Besi

**note : dapat dirubah sesuai permintaan*

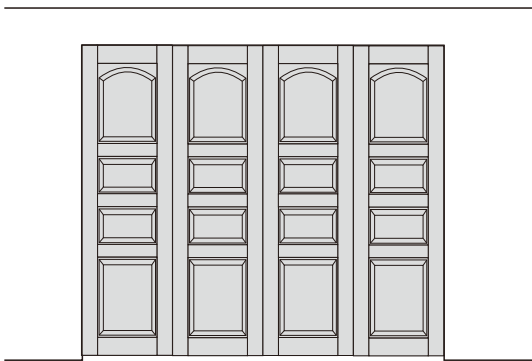

Ilustrasi 4 pintu tampak depan

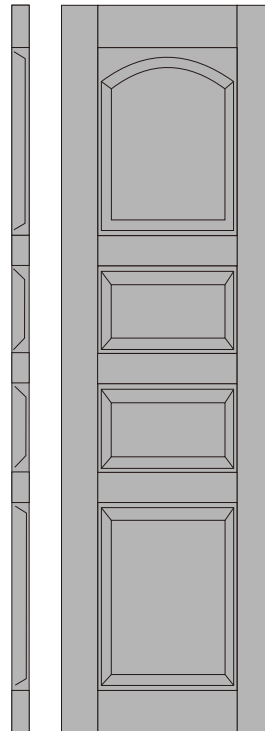

CODE : HS-03

HI-SEN HS-04

Tebal Plat : 1,2mm / 1,5mm / 2mm
 Finishing Cat Powder Coating

Bahan Plat Besi

**note : dapat dirubah sesuai permintaan*

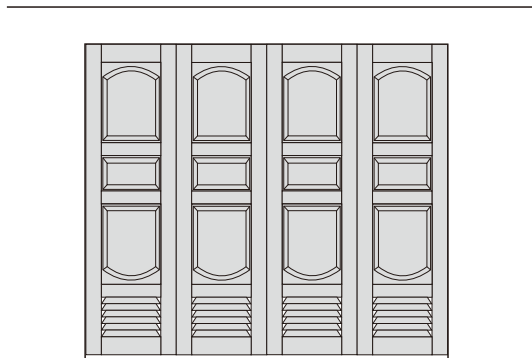

Ilustrasi 4 pintu tampak depan

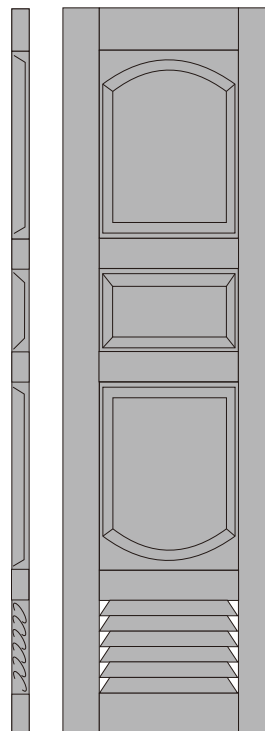

CODE : HS-04

HI-SEN HS-05

Tebal Plat : 1,2mm / 1,5mm / 2mm
 Finishing Cat Powder Coating

Bahan Plat Besi

**note : dapat dirubah sesuai permintaan*

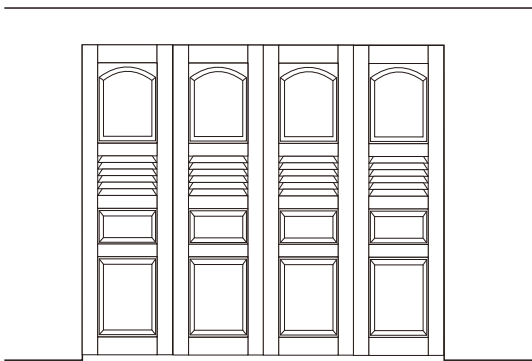

Ilustrasi 4 pintu tampak depan

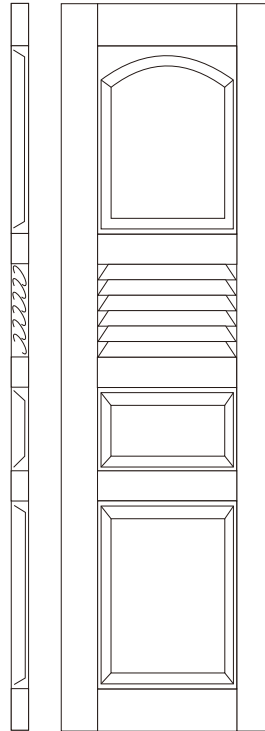

CODE : HS-05

HI-SEN HS-06

Tebal Plat : 1,2mm / 1,5mm / 2mm
 Finishing Cat Powder Coating

Bahan Plat Besi

**note : dapat dirubah sesuai permintaan*

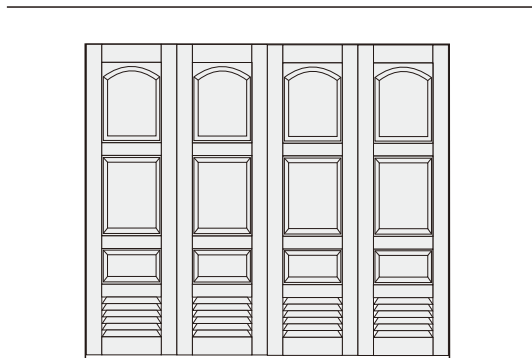

Ilustrasi 4 pintu tampak depan

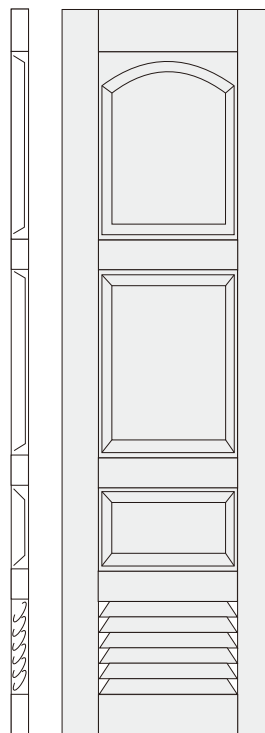

CODE : HS-06

HI-SEN HS-07

Tebal Plat : 1,2mm / 1,5mm / 2mm
 Finishing Cat Powder Coating

Bahan Plat Besi

**note : dapat dirubah sesuai permintaan*

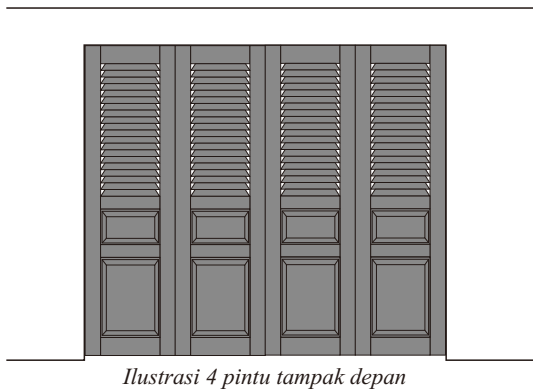

Ilustrasi 4 pintu tampak depan

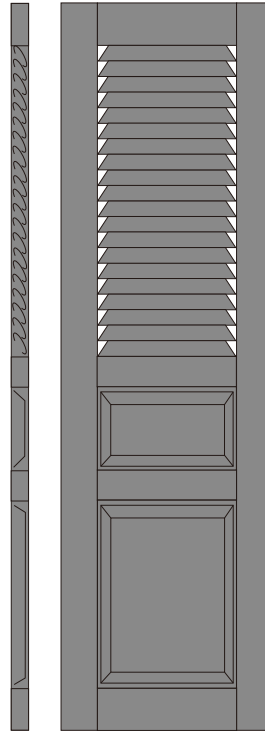

CODE : HS-07

HI-SEN HS-08

Tebal Plat : 1,2mm / 1,5mm / 2mm
 Finishing Cat Powder Coating

Bahan Plat Besi

**note : dapat dirubah sesuai permintaan*

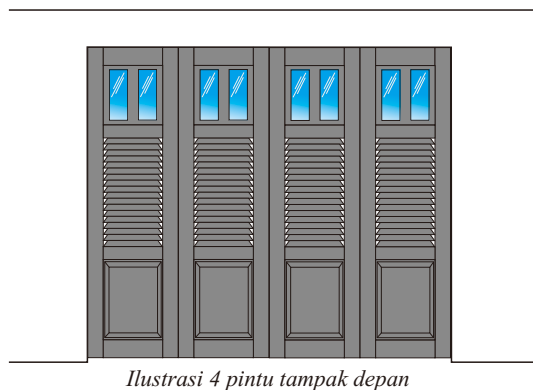

Ilustrasi 4 pintu tampak depan

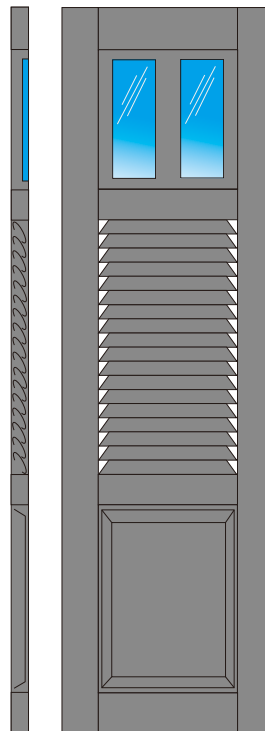

CODE : HS-08

HI-SEN HS-09

Tebal Plat : 1,2mm / 1,5mm / 2mm
 Finishing Cat Powder Coating

Bahan Plat Besi

**note : dapat dirubah sesuai permintaan*

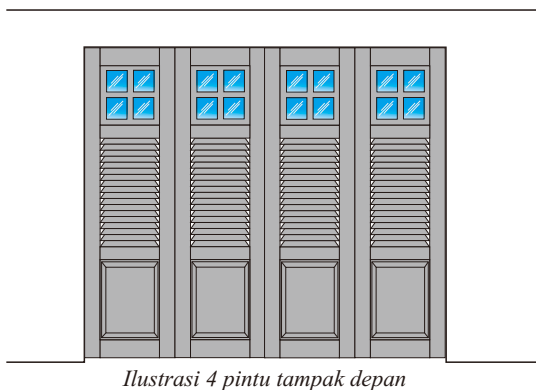

Ilustrasi 4 pintu tampak depan

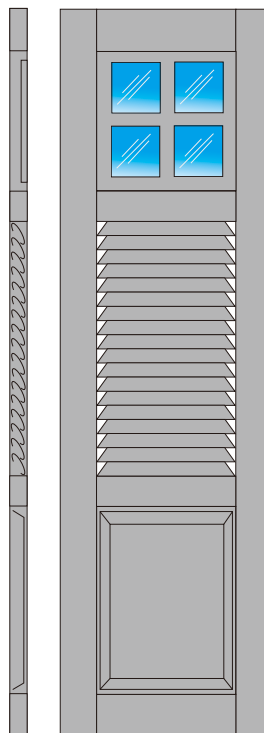

CODE : HS-09

HI-SEN HS-10

Tebal Plat : 1,2mm / 1,5mm / 2mm
 Finishing Cat Powder Coating

Bahan Plat Besi

**note : dapat dirubah sesuai permintaan*

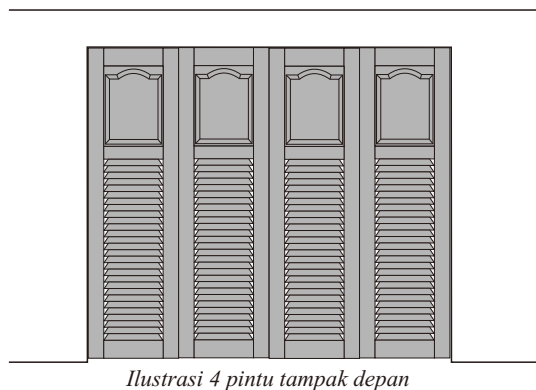

Ilustrasi 4 pintu tampak depan

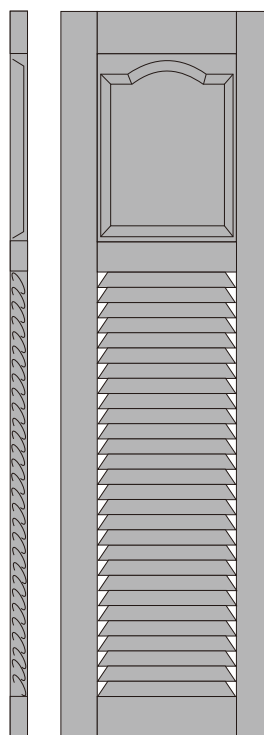

CODE : HS-10

HI-SEN HS-11

Tebal Plat : 1,2mm / 1,5mm / 2mm
 Finishing Cat Powder Coating

Bahan Plat Besi

**note : dapat dirubah sesuai permintaan*

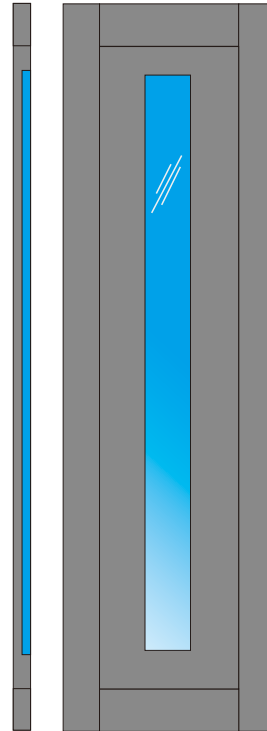
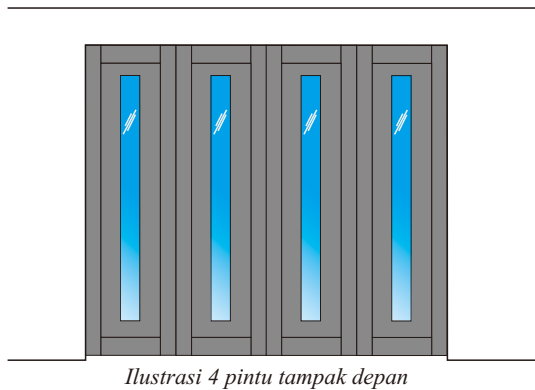

HI-SEN HS-12

Tebal Plat : 1,2mm / 1,5mm / 2mm
 Finishing Cat Powder Coating

Bahan Plat Besi

**note : dapat dirubah sesuai permintaan*

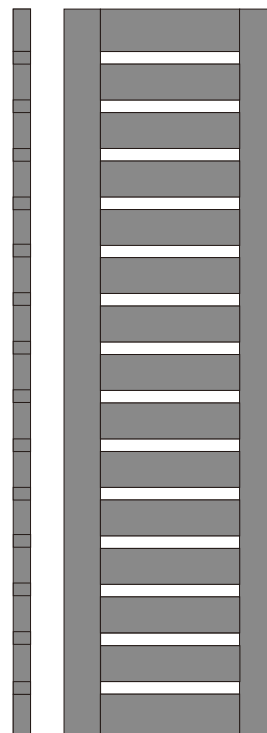
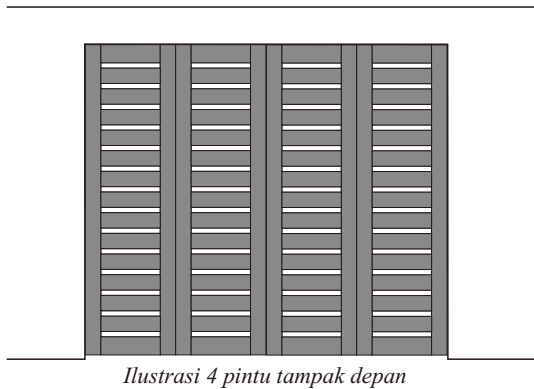

HI-SEN HS-13

Tebal Plat : 1,2mm / 1,5mm / 2mm
 Finishing Cat Powder Coating

Bahan Plat Besi

**note : dapat dirubah sesuai permintaan*

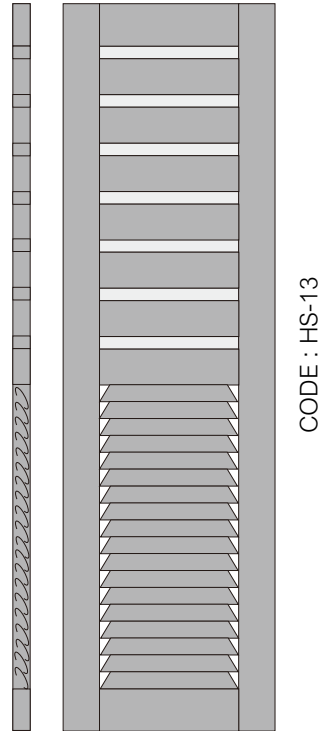
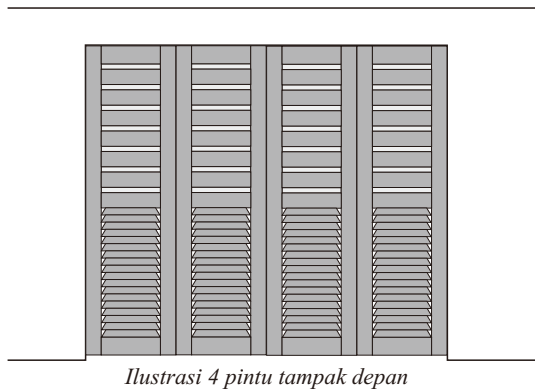

HI-SEN HS-14

Tebal Plat : 1,2mm / 1,5mm / 2mm
 Finishing Cat Powder Coating

Bahan Plat Besi

**note : dapat dirubah sesuai permintaan*

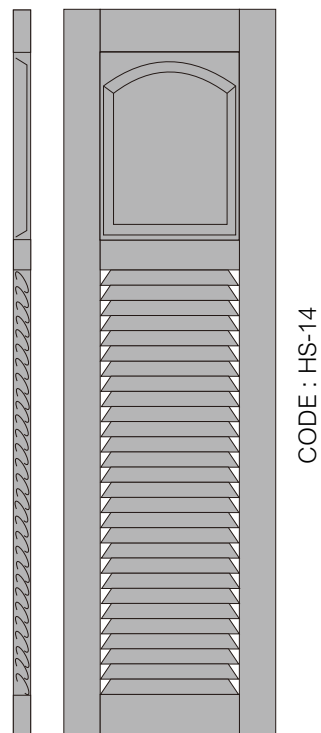
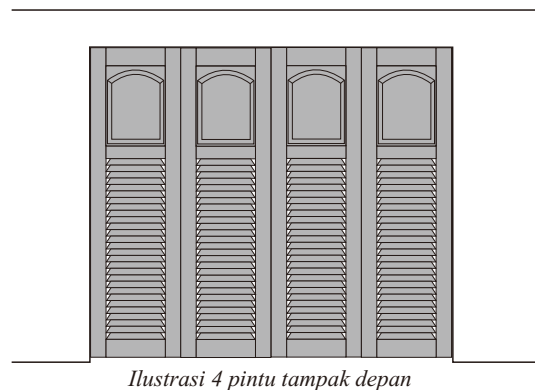

HI-SEN HS-15

Tebal Plat : 1,2mm / 1,5mm / 2mm
 Finishing Cat Powder Coating

Bahan Plat Besi

**note : dapat dirubah sesuai permintaan*

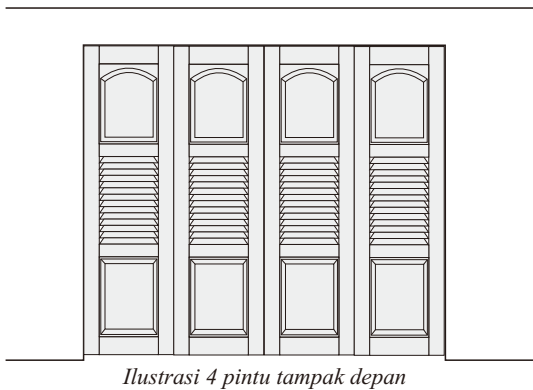

Ilustrasi 4 pintu tampak depan

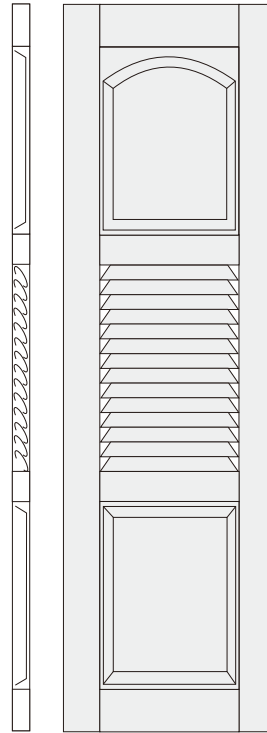

CODE : HS-15

HI-SEN HS-16

Tebal Plat : 1,2mm / 1,5mm / 2mm
 Finishing Cat Powder Coating

Bahan Plat Besi

**note : dapat dirubah sesuai permintaan*

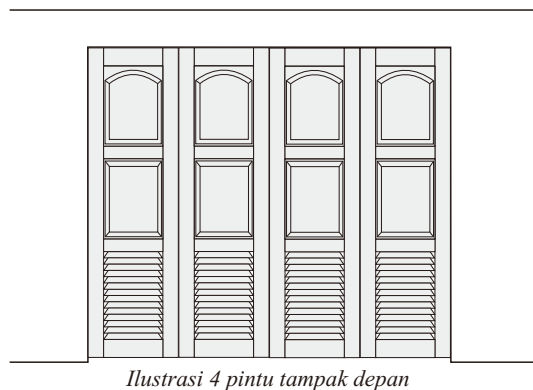

Ilustrasi 4 pintu tampak depan

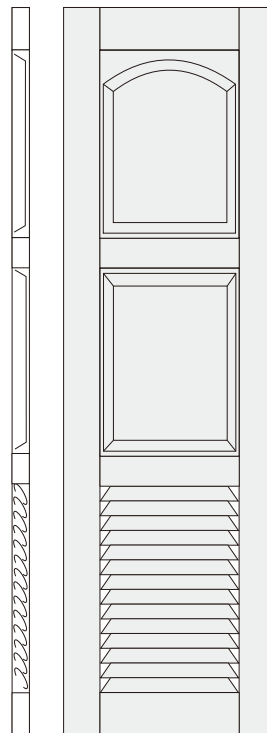

CODE : HS-16

HI-SEN HS-17

Tebal Plat : 1,2mm / 1,5mm / 2mm
 Finishing Cat Powder Coating

Bahan Plat Besi

**note : dapat dirubah sesuai permintaan*

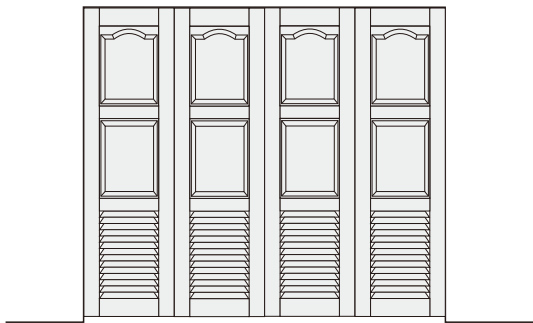

Ilustrasi 4 pintu tampak depan

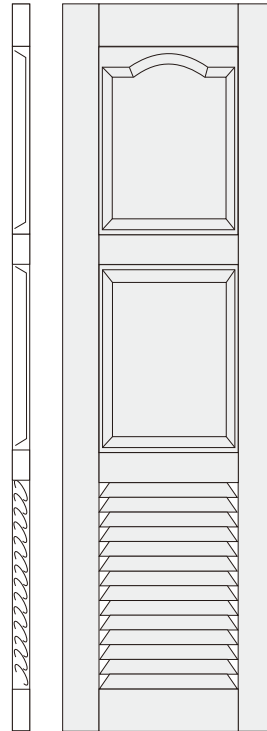

CODE : HS-17

HI-SEN HS-18

Tebal Plat : 1,2mm / 1,5mm / 2mm
 Finishing Cat Powder Coating

Bahan Plat Besi

**note : dapat dirubah sesuai permintaan*

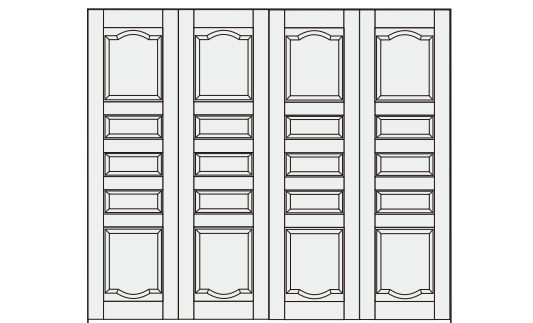

Ilustrasi 4 pintu tampak depan

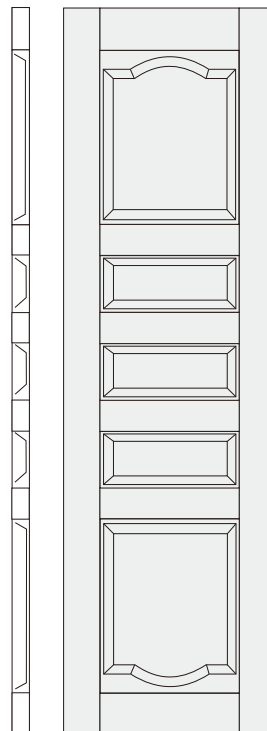

CODE : HS-18

HI-SEN HS-19

Tebal Plat : 1,2mm / 1,5mm / 2mm
 Finishing Cat Powder Coating

Bahan Plat Besi

**note : dapat dirubah sesuai permintaan*

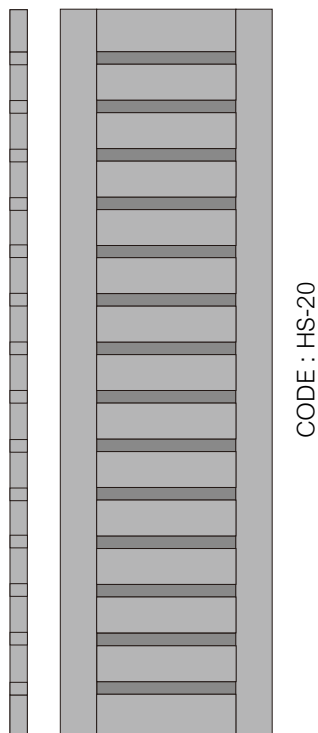
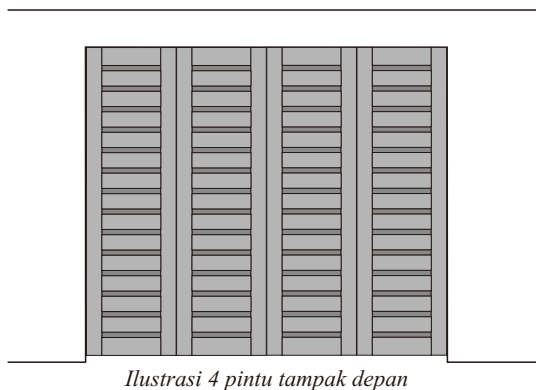

HI-SEN HS-20

Tebal Plat : 1,2mm / 1,5mm / 2mm
 Finishing Cat Powder Coating

Bahan Plat Besi

**note : dapat dirubah sesuai permintaan*

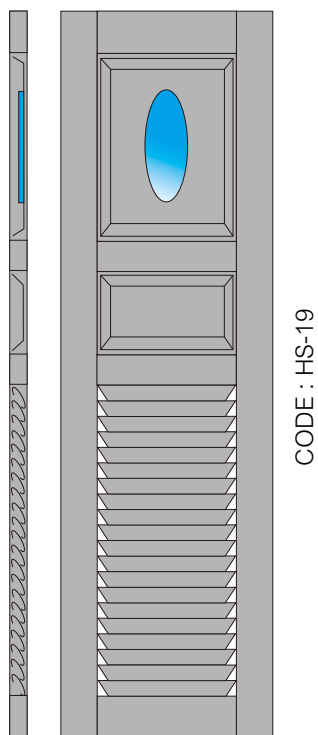
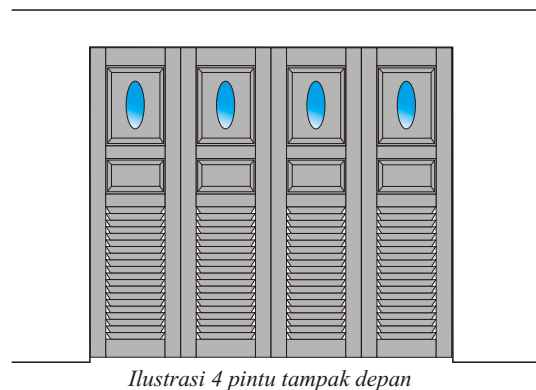

HI-SEN HS-21

Tebal Plat : 1,2mm / 1,5mm / 2mm
 Finishing Cat Powder Coating

Bahan Plat Besi

**note : dapat dirubah sesuai permintaan*

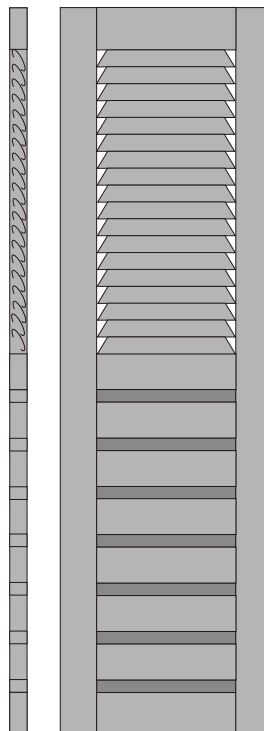
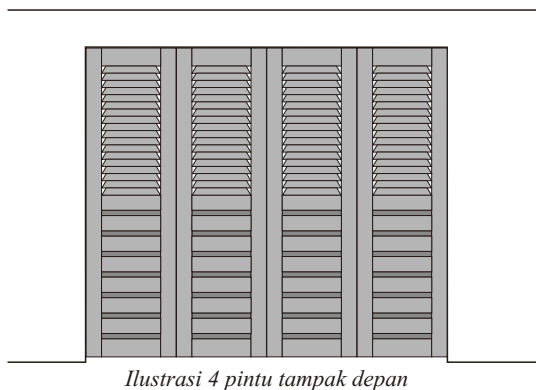

CODE : HS-21

HI-SEN HS-22

Tebal Plat : 1,2mm / 1,5mm / 2mm
 Finishing Cat Powder Coating

Bahan Plat Besi

**note : dapat dirubah sesuai permintaan*

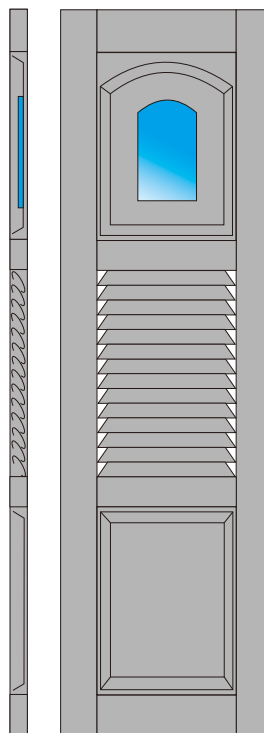
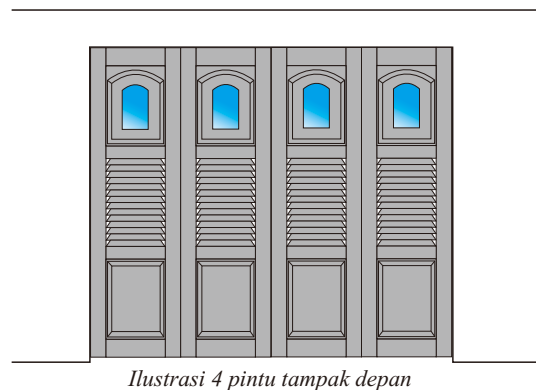

CODE : HS-22

HI-SEN HS-23

Tebal Plat : 1,2mm / 1,5mm / 2mm
 Finishing Cat Powder Coating

Bahan Plat Besi

**note : dapat dirubah sesuai permintaan*

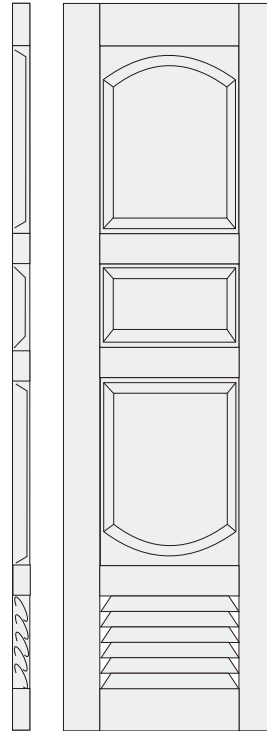
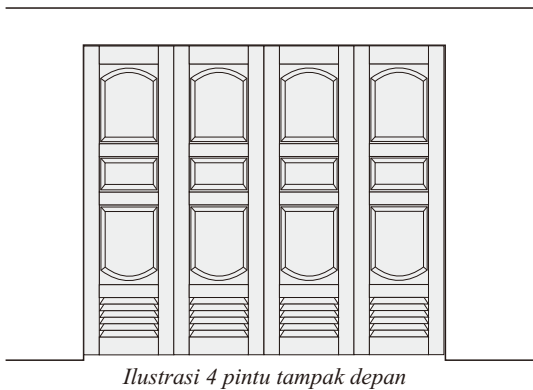

HI-SEN HS-24

Tebal Plat : 1,2mm / 1,5mm / 2mm
 Finishing Cat Powder Coating

Bahan Plat Besi

**note : dapat dirubah sesuai permintaan*

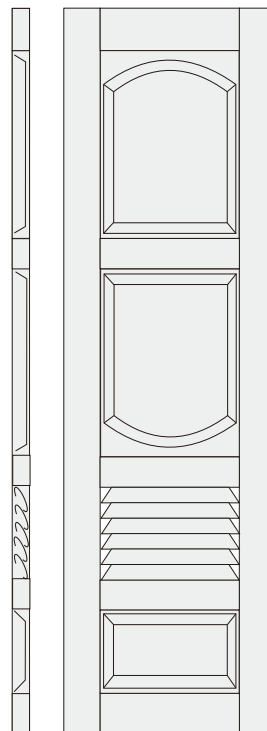
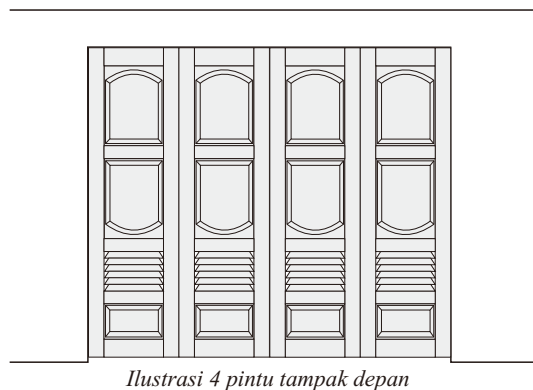

HI-SEN QUALITY



- ✓ Dibentuk Menggunakan Mesin Press dan Bending
- ✓ Tahan Terhadap Cuaca
- ✓ Tidak Mudah Tergores
- ✓ Tidak Melengkung
- ✓ Tidak Susut Karena Cuaca
- ✓ Anti Rayap
- ✓ Keamanan Luar Biasa
- ✓ Desain Mewah

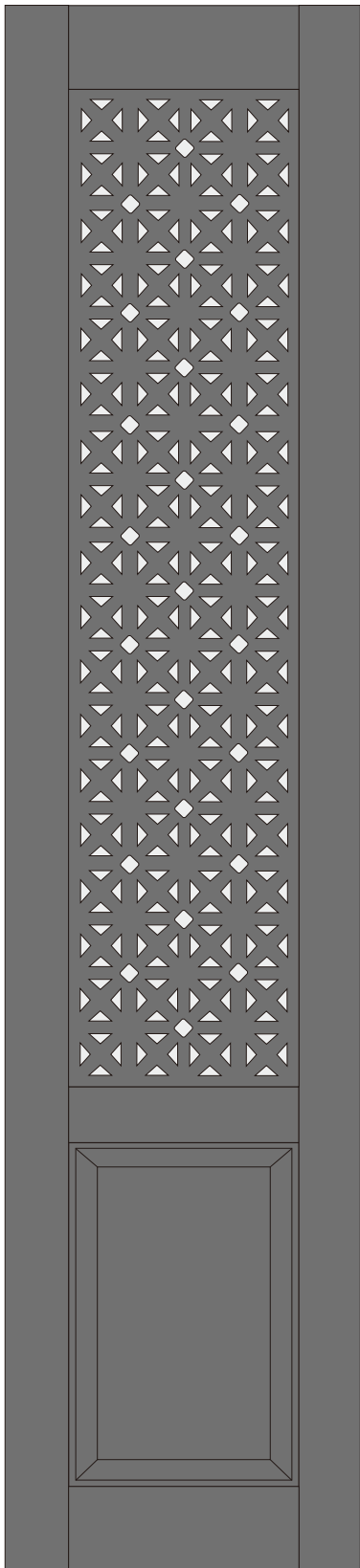

BARU

CUTTING LASER

SIMPLE & ELEGAN

CENTRAL GARASI CUTTING LASER

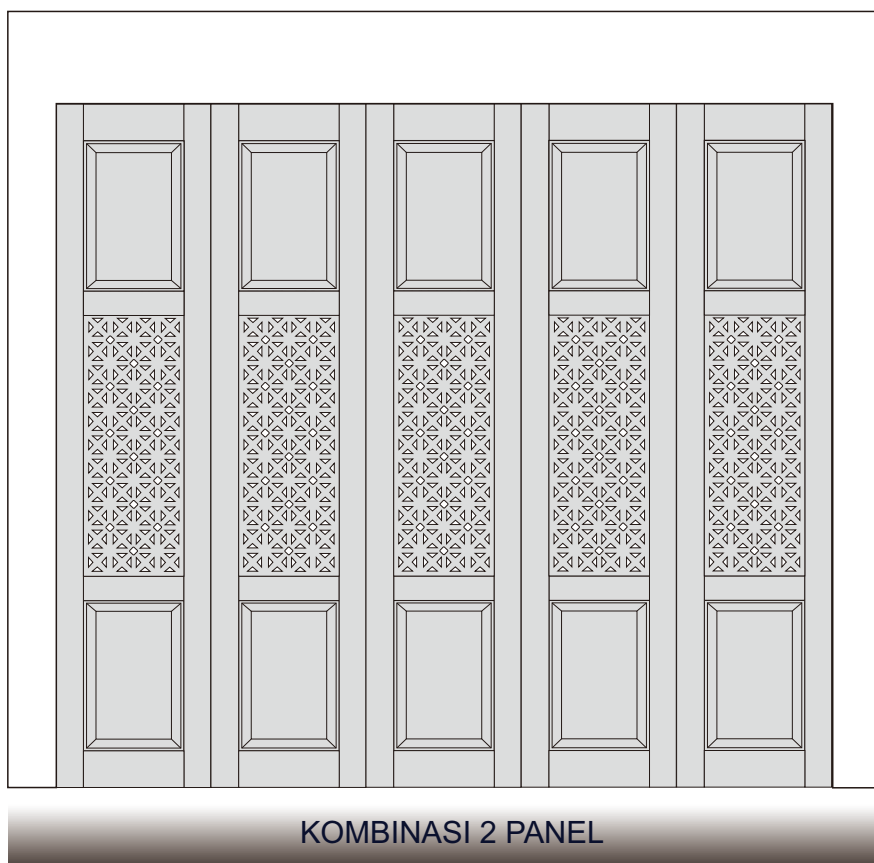
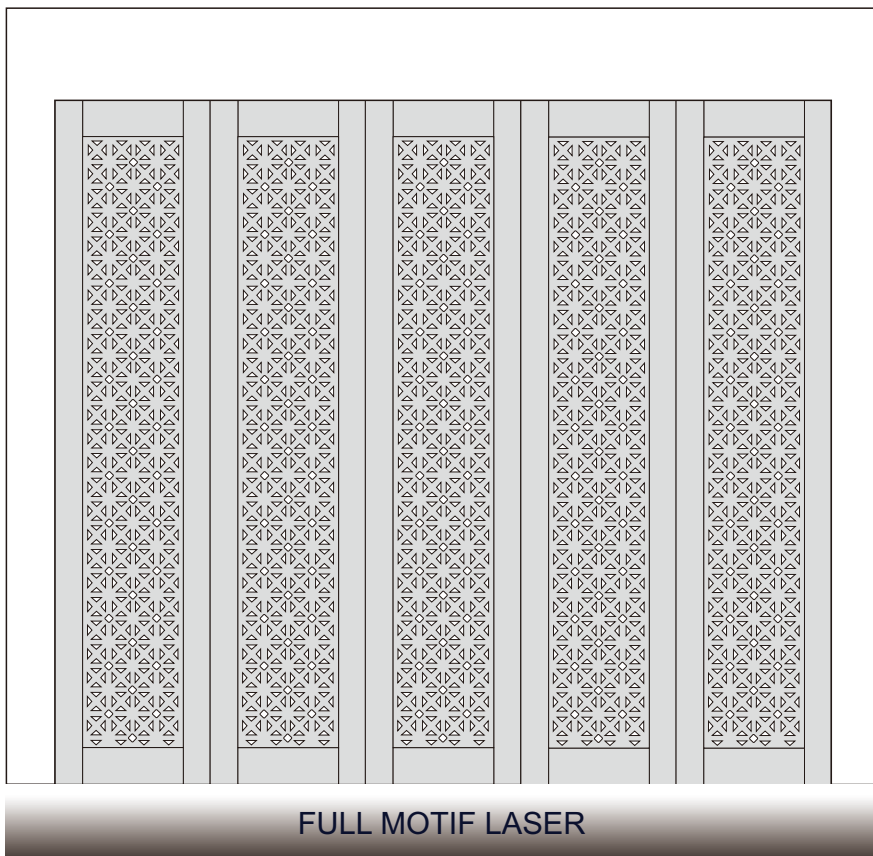

CENTRAL GARASI CUTTING LASER

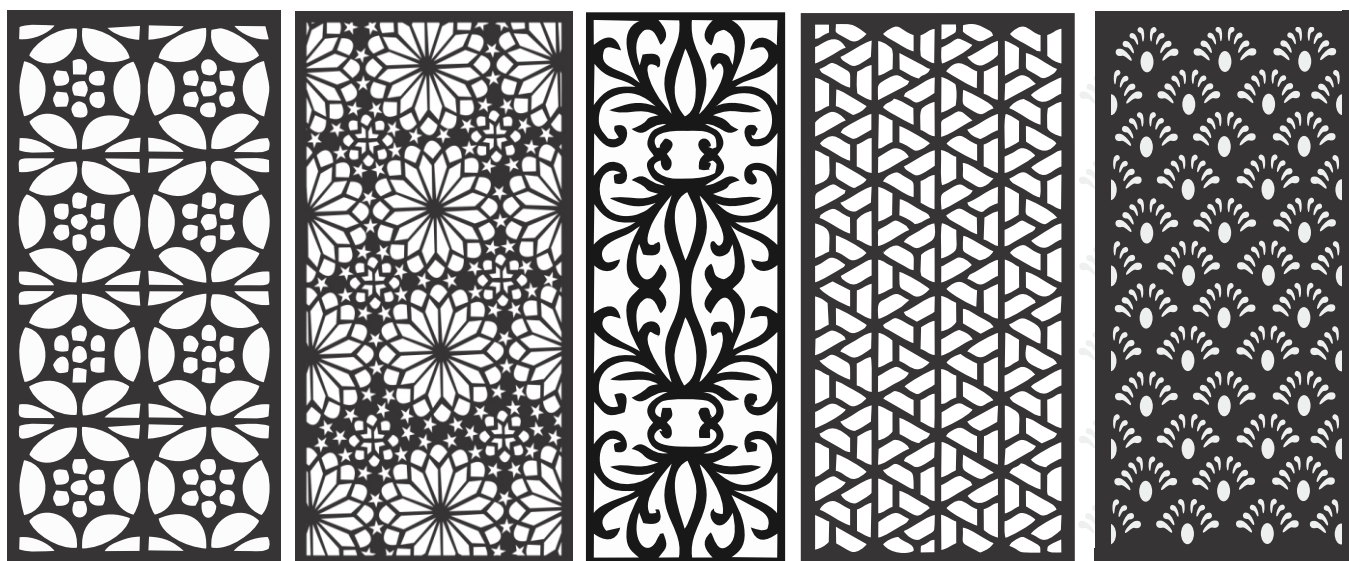
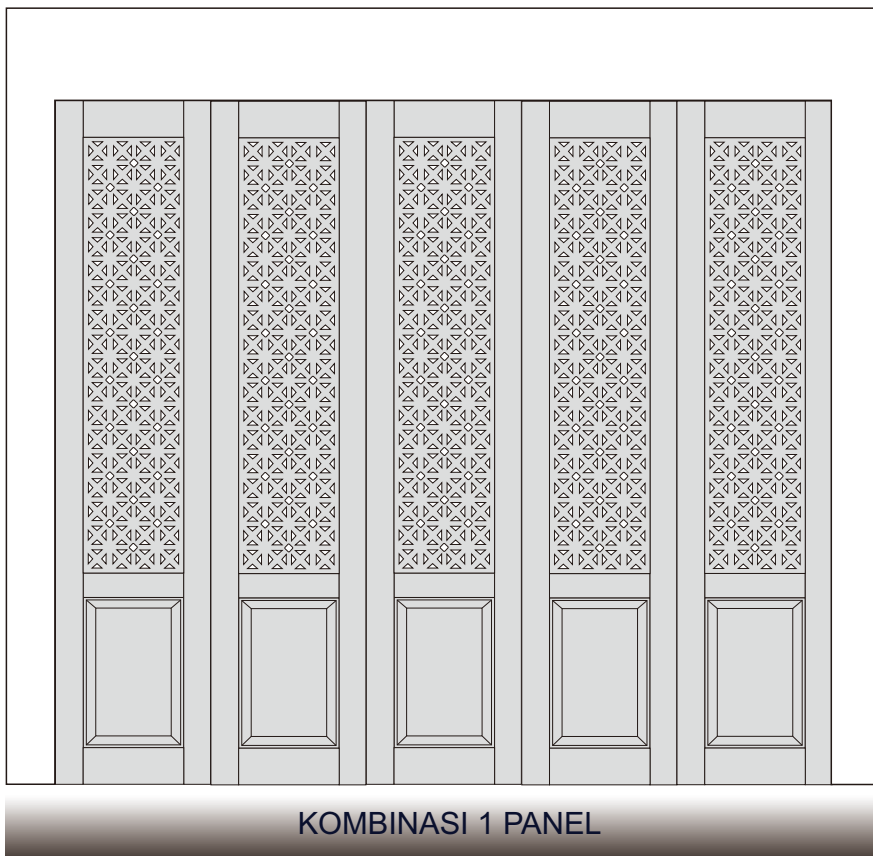

HI-SEN QUALITY

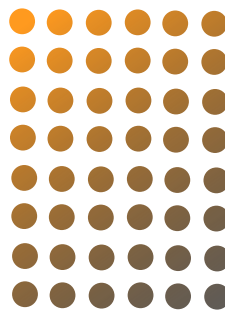
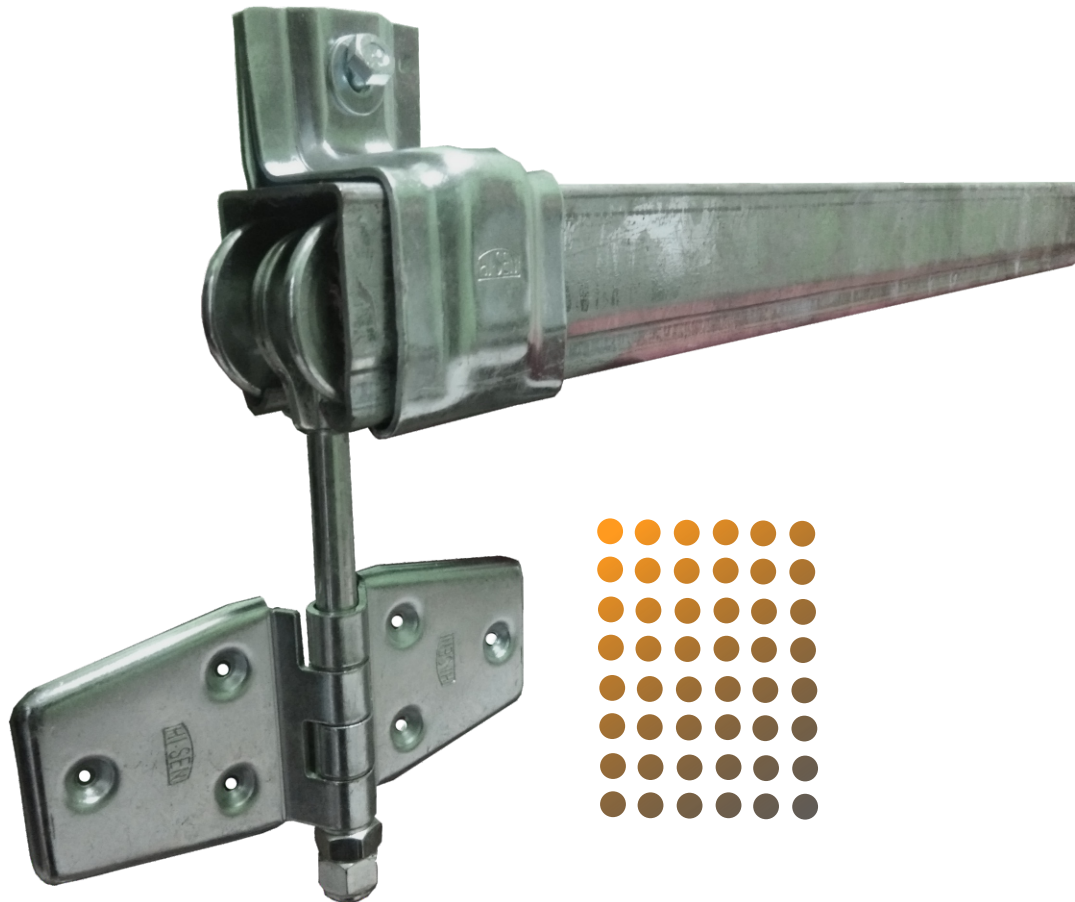

- ✓ As Roda lebih besar
- ✓ Lebih Kuat dan Kokoh
- ✓ Anti Karat
- ✓ Ketebalan Rel 1,8mm
- ✓ Ketebalan Sayap 3mm

- ✓ Dorongan Ringan
- ✓ Desain Ekslusive
- ✓ Anti Macet
- ✓ Perawatan Mudah

FINISHING POWDER COATING



PROSES PEWARNAAN



Choice of Color / Pilihan Warna :



- ✓ Warna Terang
- ✓ Tebal dan Tidak Mudah Tergores
- ✓ Tidak Berubah warna
- ✓ Mencegah dari karat



**GARANSI PRODUK
2 TAHUN**

PROJECT





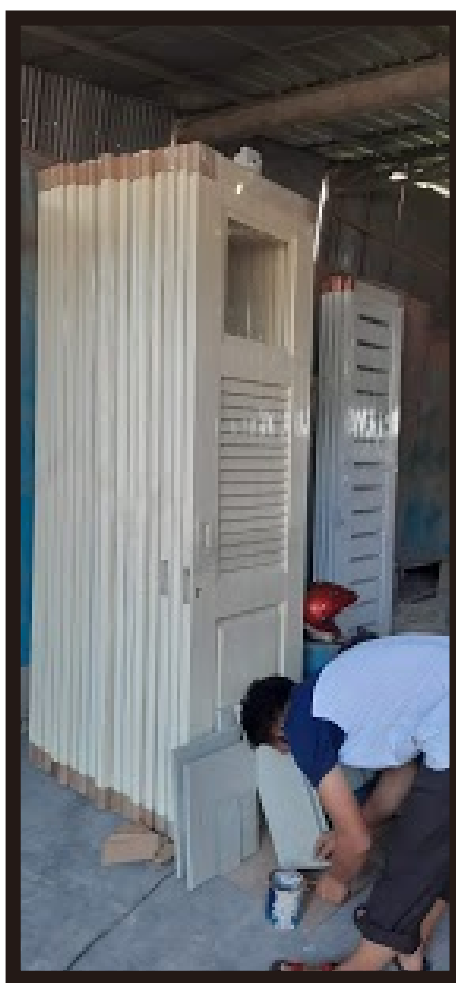
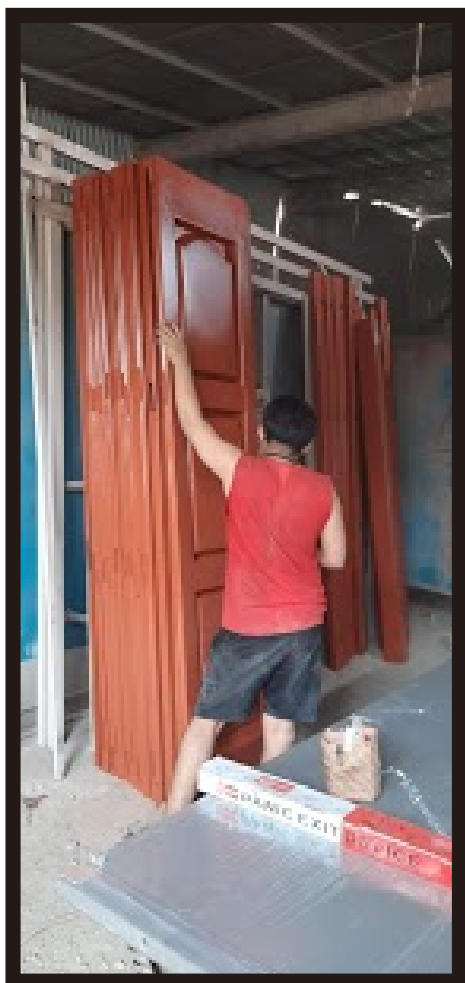





www.centralgarasi.com

Alamat :

Jalan Taman Makam Pahlawan
RT.02 RW.01, Kebon Duren
Kalimulya, Cilodong, Kota Depok
Pos: 16413

Phone :

0812 9081 8432